



ALTA
WINDOW FASHIONS
design simplified

SHEER

SHADINGS

Pricing effective August 21, 2023 and supersedes all previous pricing.
Subject to change by Alta Window Fashions.

Revised 7-1-24

SUMMARY OF REVISIONS

7-1-24 Revisions

Page 10.....Change to Edge Gap chart

Page 12.....Change to Adjacent Shading Chart

6-3-24 Revisions

All pages.....New hardware update that includes updates to headrail with new features, new options, new control systems, new hardware colors, new color coordination, updated surcharges and new size standards. No changes to fabric collections or to price grids.

4-22-24 Revisions

Pages 4-6, 9-12, 15.....Removed references to Retractable Cord Control in compliance with the CPSC Voluntary Standard

3-1-24 Revisions

Page 2.....Color Coordination of SA3-901 changed from 180 Dove Gray to 426 Squirrel Gray

10-1-23 Revisions:

Page 2.....Color Coordination of SL17B-1003 and SL14B-1003 changed from 469 Blue Creek to 885 Flex White

Page 12.....Adjacent Shadings Chart

TABLE OF CONTENTS

Product Overview

- Collection Information (includes Light Control) 2-4

Pricing Groups

- Pricing Group 1 5
- Pricing Group 2 6
- Pricing Group 3 7

Product Specifications

- Automation Size Standards 8
- Features & Options, Continuous Loop Control Drop Chart & Mounting Requirements 9
- Finished Dimensions 10
- Options and Additional Notes 11-13
- Continuous Loop Control Operation and Notes on Vane Opening, Vane Closure and Light Control 14
- Cordless Lift and Retractable Wand Operation 15

[Sheer Shadings Hardware Color Card](#) – View headrail and bottomrail colors as well as headrail fabrics for fabric-covered headrails. [Click here to view.](#)

[Sheer Shadings Dealer Sales Guide](#) – With our brand new Dealer Sales Guides, you can gain a comprehensive understanding of our products, including product characteristics and performance expectations. [Click here to explore.](#)

[Automation Price Guide](#) – Automation pricing is now featured in a separate guide for quick reference. [Click here to view.](#)

[Product Components Guide](#) – product components pages are now featured in a separate guide for quick reference. [Click here to view.](#)

Oversize Common Carrier Delivery

All orders with any quantity of shades or blinds or any continuous valance 90" or more in width are considered oversize. Therefore, a net shipping charge per oversized unit will be assessed.

Oversized orders that require expedited shipping will be quoted and charged accordingly.

Please see General Information for additional freight and shipping charge information.

COLLECTION INFORMATION

Family Name	Color Name	Family Code	Color #	Coordinating Hardware Color Number	Coordinating Hardware Color Name	Fabric Covered Headrail color	Continuous Loop Control Tensioner Color	Light Control	Price Group
Aspen 3" Translucent SL12A	Fresh Snow	SL12A	800	661	White Tiara	125	661	C	2
	Sugar Cookie	SL12A	801	320	Rich Cream	128	320	C	2
	Summer Sand	SL12A	802	320	Rich Cream	133	320	C	2
	Bedrock	SL12A	803	879	Pearl gray	321	689	C	2
	Piñon	SL12A	804	550	Ripe Pear	254	661	C	2
	Rocky Trail	SL12A	805	180	Dove Gray	227	689	C	2
	Graphite	SL12A	806	405	Gray Flannel	110	048	C	2
	Luna	SL12A	807	320	Rich Cream	127	320	C	2
Aspen Light Dimming 3" Light Dimming SL15A	Summer Sand	SL15A	802	320	Rich Cream	133	320	D	3
	Bedrock	SL15A	803	879	Pearl gray	321	689	D	3
	Piñon	SL15A	804	550	Ripe Pear	254	661	D	3
	Rocky Trail	SL15A	805	180	Dove Gray	227	689	D	3
	Graphite	SL15A	806	405	Gray Flannel	110	048	D	3
	Luna	SL15A	807	320	Rich Cream	127	320	D	3
Basketweave 3" Translucent SL14B	Sunlight	SL14B	1000	329	Summer Linen	127	320	C	2
	Raffia	SL14B	1001	862	Gardenia White	127	320	C	2
	Pinewood Forest	SL14B	1002	550	Ripe Pear	254	320	C	2
	Riverwalk	SL14B	1003	609	Falcon Gray	104	661	C	2
	Cedar Root	SL14B	1004	551	Worm Leather	133	320	C	2
	Cobblestone	SL14B	1005	276	Silverado	405	661	C	2
Basketweave Light Dimming 3" Light Dimming SL17B	Sunlight	SL17B	1000	329	Summer Linen	127	320	D	3
	Raffia	SL17B	1001	862	Gardenia White	127	320	D	3
	Pinewood Forest	SL17B	1002	550	Ripe Pear	254	320	D	3
	Riverwalk	SL17B	1003	609	Falcon Gray	104	661	D	3
	Cedar Root	SL17B	1004	551	Worm Leather	133	320	D	3
	Cobblestone	SL17B	1005	276	Silverado	405	661	D	3
Classic 2-1/2" Translucent N8	Applesauce	N8	226	550	Ripe Pear	229	320	C	1
	Beige Glow	N8	203	320	Rich Cream	127	320	C	1
	Cityscape	N8	238	276	Silverado	266	661	C	1
	Dried Basil	N8	65	550	Ripe Pear	229	689	C	1
	French Bread	N8	222	658	Tan Tango	403	661	C	1
	Snow Cap	N8	201	661	White Tiara	125	661	C	1
	Sun Dream	N8	202	320	Rich Cream	127	320	C	1
	Oak Plank	N8	297	550	Ripe Pear	133	320	C	1
Coastal 3" Translucent SA3	Foam	SA3	700	661	White Tiara	125	661	C	1
	Mystery	SA3	761	276	Silverado	234	661	C	1
	Sand	SA3	701	320	Rich Cream	126	661	C	1
	Sculpting Clay	SA3	760	180	Dove Gray	229	689	C	1
	Summer Splash	SA3	900	329	Summer Linen	127	320	C	1
	Silverton	SA3	901	550	Ripe Pear	133	320	C	1
	Hint of Sage	SA3	902	550	Ripe Pear	254	320	C	1
	Hint of Rosé	SA3	903	658	Tan Tango	403	661	C	1
Oceanside 3" Translucent SL13O	Sandbar	SL13O	900	329	Summer Linen	127	320	C	2
	Macadamia	SL13O	901	862	Gardenia White	128	320	C	2
	Beach Pebbles	SL13O	902	276	Silverado	405	661	C	2
	Palm	SL13O	903	550	Ripe Pear	254	689	C	2
	Terra	SL13O	904	879	Pearl gray	516	689	C	2
	Surfside	SL13O	905	450	Skyline (Midnight Blue)	937	661	C	2
Oceanside Light Dimming 3" Light Dimming SL16O	Sandbar	SL16O	900	329	Summer Linen	127	320	D	3
	Macadamia	SL16O	901	862	Gardenia White	128	320	D	3
	Beach Pebbles	SL16O	902	276	Silverado	405	661	D	3
	Palm	SL16O	903	550	Ripe Pear	254	689	D	3
	Terra	SL16O	904	879	Pearl gray	516	689	D	3
	Surfside	SL16O	905	450	Skyline (Midnight Blue)	937	661	D	3
Retreat 2" Light Dimming SR2	Alpine	SR2	300	885	Flex White	125	661	D	3
	Antique	SR2	302	329	Summer Linen	127	320	D	3
	Nickel	SR2	332	276	Silverado	234	661	D	3
	Sunset	SR2	301	320	Rich Cream	128	661	D	3
	Swiss Coffee	SR2	330	656	Golden Straw	143	320	D	3
	Cappuccino	SR2	360	550	Ripe Pear	303	689	D	3
	Green Tea	SR2	361	550	Ripe Pear	229	661	D	3
	Whipping Cream	SR2	362	785	Aspen White	204	661	D	3
Retreat 3" Light Dimming SR3	Alpine	SR3	300	885	Flex White	125	661	D	3
	Antique	SR3	302	329	Summer Linen	127	320	D	3
	Nickel	SR3	332	276	Silverado	234	661	D	3
	Sunset	SR3	301	320	Rich Cream	128	320	D	3
	Swiss Coffee	SR3	330	656	Golden Straw	143	320	D	3
	Cappuccino	SR3	360	550	Ripe Pear	303	689	D	3
	Green Tea	SR3	361	550	Ripe Pear	229	661	D	3
	Whipping Cream	SR3	362	785	Aspen White	204	661	D	3

*Fabric-covered headrail is color-coordinated to fabric. If an override is chosen, please choose from a color in the Fabric-Covered Headrail color-coordination chart on page 4

*When Continuous Loop Control is ordered, the shade is color coordinated to one of the tensioners in the chart on Page 4. You may override the tensioner color and choose another color if desired.

*Light Filtering/Translucent - Softly diffuses sunlight and provides a moderate degree of privacy as only shadows will be discernible.

*Room Darkening/Light Dimming - Dramatically reduces light. Provides privacy against most direct light. Images, shapes and people are not discernible.

LIGHT CONTROL DEFINITIONS	
A	Sheer - Filtered light for an open, softened view, UV protection and glare reflection, when privacy is not a concern.
B	Semi-Sheer - Softly diffuses light while offering minimal privacy. Images, shapes and people can be seen with some clarity.
C	Light Filtering/Translucent - Softly diffuses sunlight and provides a moderate degree of privacy as only shadows will be discernible.
D	Room Darkening/Light Dimming - Dramatically reduces light. Provides privacy against most direct light. Images, shapes and people are not discernible.
E	Blackout - Provides the ultimate in light control and privacy; perfect for bedrooms, nursery, or media rooms. Pair with side channels or privacy light block for additional privacy. (Side channels where applicable)

COLLECTION INFORMATION

Family Name	Color Name	Family Code	Color #	Coordinating Hardware Color Number	Coordinating Hardware Color Name	Fabric Covered Headrail color	Continuous Loop Control Tensioner Color	Light Control	Price Group
Sophisticate 2" Translucent SS2	Eggnog	SS2	605	320	Rich Cream	127	320	C	1
	Glacier	SS2	616	661	White Tiara	125	661	C	1
	Lily	SS2	601	885	Flex White	125	661	C	1
	Mist	SS2	602	661	White Tiara	126	661	C	1
	Moonlight	SS2	603	320	Rich Cream	127	320	C	1
	Natural Linen	SS2	619	550	Ripe Pear	229	661	C	1
	Pearl Grey	SS2	617	320	Rich Cream	127	320	C	1
	Sandstone	SS2	606	320	Rich Cream	127	661	C	1
	Sophisticate 3" Translucent SS3	Eggnog	SS3	605	320	Rich Cream	127	320	C
Glacier		SS3	616	661	White Tiara	125	661	C	1
Lily		SS3	601	885	Flex White	125	661	C	1
Mist		SS3	602	661	White Tiara	126	661	C	1
Moonlight		SS3	603	320	Rich Cream	127	661	C	1
Natural Linen		SS3	619	550	Ripe Pear	229	661	C	1
Pearl Grey		SS3	617	320	Rich Cream	127	320	C	1
Sandstone		SS3	606	320	Rich Cream	127	661	C	1
Flint		SS3	796	276	Silverado	321	661	C	1
Foothills		SS3	797	180	Dove Gray	133	661	C	1
Sandy Cove		SS3	799	656	Golden Straw	143	320	C	1
Villa 2-1/2" Light Dimming N6	Castle Stone	N6	226	862	Gardenia White	229	320	D	3
	Coral	N6	202	320	Rich Cream	127	320	D	3
	Cotton	N6	201	885	Flex White	125	661	D	3
	Fawn	N6	203	862	Gardenia White	128	320	D	3
	Graphite	N6	238	276	Silverado	266	661	D	3
	Spanish Olive	N6	65	550	Ripe Pear	229	320	D	3
	Playa	N6	298	658	Tan Tango	403	320	D	3
	Washed Oak	N6	299	550	Ripe Pear	133	661	D	3

*Fabric-covered headrail is color-coordinated to fabric. If an override is chosen, please choose from a color in the Fabric-Covered Headrail color-coordination chart on page 4.

*When Continuous Loop Control is ordered, the shade is color coordinated to one of the tensioners in the chart on Page 4. You may override the tensioner color and choose another color if desired.

*Light Filtering/Translucent - Softly diffuses sunlight and provides a moderate degree of privacy as only shadows will be discernible.

*Room Darkening/Light Dimming - Dramatically reduces light. Provides privacy against most direct light. Images, shapes and people are not discernible.

LIGHT CONTROL DEFINITIONS	
A	Sheer - Filtered light for an open, softened view, UV protection and glare reflection, when privacy is not a concern.
B	Semi-Sheer - Softly diffuses light while offering minimal privacy. Images, shapes and people can be seen with some clarity.
C	Light Filtering/Translucent - Softly diffuses sunlight and provides a moderate degree of privacy as only shadows will be discernible.
D	Room Darkening/Light Dimming - Dramatically reduces light. Provides privacy against most direct light. Images, shapes and people are not discernible.
E	Blackout - Provides the ultimate in light control and privacy; perfect for bedrooms, nursery, or media rooms. Pair with side channels or privacy light block for additional privacy. (Side channels where applicable)

COLLECTION INFORMATION

Fabric-covered headrail is color-coordinated to fabric.

Please refer to your Hardware Color Card to view samples of each of the 32 FCH colors or click here for a digital version.

If an override is chosen, please choose from a color in the Fabric- Covered Headrail color-coordination chart below.

Fabric-Covered Headrail Color Chart	
FCH Color Number	FCH Color Name
104	Cloud
107	Honey Beige
110	Treffle
116	Turtledove
125	Radiant White
126	White Diamond
127	Linen Flirt
128	Misty Almond
133	Feather Fantasy
135	Whispering Heather
143	Wedding Cake
160	Pêche
204	Summer Linen
227	Garden Trellis
229	Ivoire
234	Foggy Mist
254	Conch Shell
266	Grason
290	Sea Ranch
303	Kiawah
321	Silver Reflection
324	Champagne Shine
402	Wild Rice
403	Briar Wood
405	Aspen Bark
516	Feathered Down
623	Magicians Cloth
627	Spyglass
750	Graphite
920	Morning Shadow
933	Haze
937	Aire

Continuous Loop Control Universal Cord Tensioner Colors	
Color Number	Description
661	White
320	Vanilla
903	Light Brown
689	Dark Brown
048	Black

Note: When Continuous Loop Control is ordered, the shade is color coordinated to one of the tensioners above. You may override the tensioner color and choose another color if desired.

2" Translucent Sophisticate (SS2) **2 1/2" Translucent Classic (N8)** **3" Translucent Sophisticate (SS3) Coastal (SA3)**

GROUP 1

WIDTH TO:	24"	30"	36"	42"	48"	54"	60"	66"	72"	76"	84"	90"	96"	102"	109"	120"
HEIGHT TO:																
36"	\$552	621	690	755	824	900	962	1034	1218	1285	1358	1427	1496	1588	1778	1941
42"	580	656	728	807	880	959	1034	1111	1293	1375	1452	1526	1603	1702	1903	2080
48"	615	694	777	856	937	1020	1108	1192	1378	1462	1544	1626	1714	1812	2029	2212
54"	639	728	814	907	998	1086	1179	1279	1462	1548	1640	1733	1827	1941	2174	2374
60"	670	766	859	952	1044	1154	1255	1361	1537	1640	1736	1843	1947	2080	2340	2553
66"	700	804	904	1004	1111	1222	1335	1449	1620	1733	1847	1963	2074	2220	2505	2736
72"	728	842	948	1055	1172	1293	1413	1530	1714	1830	1950	2074	2191	2351	2657	2901
78"	749	866	982	1104	1225	1348	1471	1603	1789	1922	2047	2178	2298	2467	2794	3049
84"	784	904	1024	1158	1285	1419	1559	1689	1886	2026	2160	2291	2421	2602	2949	3214
90"	811	937	1072	1214	1348	1496	1634	1775	1974	2119	2264	2405	2546	2728	3094	3377
96"	845	979	1114	1265	1413	1559	1705	1853	2067	2220	2370	2518	2670	2865	3248	3545
102"	962	1121	1272	1433	1588	1730	1929	2123	2267	2421	2581	2725	2876	3059	3452	3765
108"	1014	1175	1335	1509	1669	1824	2029	2237	2387	2550	2715	2873	3028	3217	3633	3967
114"	1076	1244	1419	1603	1778	1937	2157	2374	2534	2712	2876	3046	3210	3414	3851	4202
120"	1158	1335	1520	1717	1892	2074	2307	2538	2715	2897	3083	3260	3438	3655	4119	4498

STANDARD FEATURES

- Light Block Strip on top of headrail for Inside Mounts(see page 13 for details)
- Color Coordinated Headrail
- Snap-in Bracket Style
- Cord Tilt & Lift
- Color-Coordinated Hardware

OPTIONS: EXTRA CHARGE

- Fabric Covered Headrail **add \$35 per shading**
- Hardware Color Substitution Surcharge **add \$30 per shading**
- Cordless Lift Surcharge **add \$90 per shading**
- Cordless Lift Two-on-One Headrail **add \$180 per shading**
- Retractable Wand **add \$90 per shading**
- Retractable Wand 2 On 1 Headrail **add \$180 per shading**

OPTIONS: NO CHARGE – SPECIFY ON ORDER

- Tilt Only Shadings 6" to 11-7/8" (Continuous Loop Control Only)
- Two-On-One Headrail – price as 2 separate shades
- Control Positions (R or L)
- Spacer Blocks
- Extension Brackets
- Hold-Down Brackets
- Back Cover for Inside or End Mounts
- Dust Cover for Outside Mounts

Notes:

- Hardware Color Substitution is only available when the Fabric-Covered Headrail option is not selected. Please review Collection Information pages for Coordinating Hardware Color
 - When Fabric-Covered Headrail is selected the underlying headrail color will always be white and the end caps will still be color coordinated.
 - Fabric-covered headrail is color-coordinated to fabric. If an override is chosen, please choose from a color in the Fabric- Covered Headrail color-coordination chart on page 4

SIZE STANDARDS-Single Panel	Continuous Loop Control	Retractable Wand
Minimum ordered width	12"	12"
Minimum ordered width – tilt only	6"	N/A
Maximum ordered width	120"	120"
Maximum ordered width end mount	48"	48"
Maximum ordered width – tilt only	11-7/8"	N/A
Minimum ordered height	16"	16"
Maximum ordered height-(see notes for limitations)	See Max Height Chart	See Max Height Chart

SIZE STANDARDS-Single Panel	Cordless Lift
Minimum ordered width	18"
Maximum ordered width	120"
Maximum ordered width end mount	48"
Minimum ordered height	12"
Maximum ordered height-All Fabrics (see notes for limitations)	84"

SIZE STANDARDS- TWO-ON-ONE HEADRAIL	Continuous Loop Control	Retractable Wand	Cordless Lift
Minimum ordered width	24"	24"	36"
Maximum ordered width (Overall)	144"	144"	144"
Maximum ordered width (Larger Panel)*	108"	108"	108"
Maximum height-(see notes for limitations)	See Max Height Chart	See Max Height Chart	84"
Center gap	3/8"	3/8"	3/8"

Max Height Chart for Continuous Loop Control and Retractable Wand.		
Maximum Height for Cordless is 84" on all fabrics.		
Fabric Code	Fabric Name	Max. Height
N6	Villa	102
N8	Classic	120
SA3	Coastal	90
SR2	Retreat	102
SR3	Retreat	102
SS2	Sophisticate	102
SS3	Sophisticate	120
SL12A	Aspen	120"
SL13O	Oceanside	120"
SL14B	Basketweave	120"
SL15A	Aspen Light Dimming	102"
SL16O	Oceanside Light Dimming	102"
SL17B	Basketweave Light Dimming	102"

For All Control Options - Maximum ordered width for end mount (EB) shadings is 48"
Retractable Wand - Maximum heights apply to shadings over 17 1/2" wide.
 Maximum height for shadings 12" to 17 1/2" wide is 106" or the max height specified in the Max Height chart if shorter than 106", max would be whichever is shorter.
Cordless Lift - 84" maximum height applies to shadings over 24" wide. Maximum height for shadings 18" to 22" wide is 60". Maximum height for shadings 22 1/8" to 24" wide is 72".
Two-On-One Headrail - Maximum single panel width is 108". With unequal panels, the smaller panel must be at least one-third the width of the larger. Maximum height limitations apply to each individual panel. Two-On-One Headrail option not available for end mount applications.

Automation charts on page 8
BLISS Automation pricing. [Click here to view.](#)
Somfy Automation pricing. [Click here to view.](#)
PowerWand pricing. [Click here to view.](#)

3" Translucent
Aspen (SL12A)
Oceanside (SL130)
Basketweave (SL14B)

GROUP 2

WIDTH TO:	24"	30"	36"	42"	48"	54"	60"	66"	72"	76"	84"	90"	96"	102"	109"	120"
HEIGHT TO:																
36"	\$606	683	760	834	910	990	1058	1137	1332	1416	1496	1575	1647	1747	1960	2140
42"	639	725	804	887	973	1055	1137	1222	1427	1512	1596	1682	1764	1870	2088	2281
48"	673	763	856	937	1031	1124	1222	1310	1512	1603	1695	1789	1882	1993	2233	2439
54"	703	801	900	998	1090	1192	1293	1399	1603	1705	1799	1906	2020	2136	2401	2622
60"	735	842	945	1047	1154	1268	1386	1496	1689	1799	1916	2029	2146	2288	2570	2808
66"	769	877	998	1108	1222	1345	1468	1591	1783	1909	2033	2157	2281	2443	2755	3010
72"	804	924	1041	1158	1289	1427	1551	1682	1882	2020	2149	2281	2408	2584	2959	3228
78"	824	948	1083	1214	1345	1489	1623	1764	1970	2113	2257	2395	2531	2718	3173	3461
84"	859	998	1124	1268	1419	1562	1714	1853	2074	2226	2374	2660	2780	2890	3403	3714
90"	897	1031	1172	1329	1489	1640	1796	1947	2168	2329	2614	2777	2897	3076	3568	3895
96"	1024	1172	1329	1493	1643	1789	1970	2146	2411	2564	2718	2869	3018	3228	3747	4089
102"	1172	1342	1512	1695	1843	1984	2229	2453	2645	2800	2955	3100	3255	3447	3975	4343
108"	1231	1410	1588	1780	1936	2084	2341	2576	2778	2940	3103	3255	3418	3620	4174	4561
114"	1293	1480	1667	1869	2032	2188	2458	2705	2917	3087	3258	3418	3589	3801	4383	4789
120"	1357	1554	1751	1963	2134	2297	2581	2840	3062	3242	3421	3589	3769	3991	4602	5028

STANDARD FEATURES

- Light Block Strip on top of headrail for Inside Mounts(see page 13 for details)
- Color Coordinated Headrail
- Snap-in Bracket Style
- Cord Tilt & Lift
- Color-Coordinated Hardware

OPTIONS: EXTRA CHARGE

- Fabric Covered Headrail add \$35 per shading
- Hardware Color Substitution Surcharge add \$30 per shading
- Cordless Lift Surcharge add \$90 per shading
- Cordless Lift Two-on-One Headrail add \$180 per shading
- Retractable Wand add \$90 per shading
- Retractable Wand 2 On 1 Headrail add \$180 per shading

OPTIONS: NO CHARGE – SPECIFY ON ORDER

- Tilt Only Shadings 6" to 11-7/8" (Continuous Loop Control Only)
- Two-On-One Headrail – price as 2 separate shades
- Control Positions (R or L)
- Spacer Blocks
- Extension Brackets
- Hold-Down Brackets
- Back Cover for Inside or End Mounts
- Dust Cover for Outside Mounts

Notes:

- Hardware Color Substitution is only available when the Fabric-Covered Headrail option is not selected. Please review Collection Information pages for Coordinating Hardware Color
 - When Fabric-Covered Headrail is selected the underlying headrail color will always be white and the end caps will still be color coordinated.
 - Fabric-covered headrail is color-coordinated to fabric. If an override is chosen, please choose from a color in the Fabric- Covered Headrail color-coordination chart on page 4

SIZE STANDARDS-Single Panel	Continuous Loop Control	Retractable Wand
Minimum ordered width	12"	12"
Minimum ordered width – tilt only	6"	N/A
Maximum ordered width	120"	120"
Maximum ordered width end mount	48"	48"
Maximum ordered width – tilt only	11-7/8"	N/A
Minimum ordered height	16"	16"
Maximum ordered height-(see notes for limitations)	See Max Height Chart	See Max Height Chart

SIZE STANDARDS-Single Panel	Cordless Lift
Minimum ordered width	18"
Maximum ordered width	120"
Maximum ordered width end mount	48"
Minimum ordered height	12"
Maximum ordered height-All Fabrics (see notes for limitations)	84"

SIZE STANDARDS- TWO-ON-ONE HEADRAIL	Continuous Loop Control	Retractable Wand	Cordless Lift
Minimum ordered width	24"	24"	36"
Maximum ordered width (Overall)	144"	144"	144"
Maximum ordered width (Larger Panel)*	108"	108"	108"
Maximum height-(see notes for limitations)	See Max Height Chart	See Max Height Chart	84"
Center gap	3/8"	3/8"	3/8"

Max Height Chart for Continuous Loop Control and Retractable Wand.		
Maximum Height for Cordless is 84" on all fabrics.		
Fabric Code	Fabric Name	Max. Height
N6	Villa	102
N8	Classic	120
SA3	Coastal	90
SR2	Retreat	102
SR3	Retreat	102
SS2	Sophisticate	102
SS3	Sophisticate	120
SL12A	Aspen	120"
SL130	Oceanside	120"
SL14B	Basketweave	120"
SL15A	Aspen Light Dimming	102"
SL16O	Oceanside Light Dimming	102"
SL17B	Basketweave Light Dimming	102"

For All Control Options - Maximum ordered width for end mount (EB) shadings is 48"

Retractable Wand - Maximum heights apply to shadings over 17 1/2" wide.

Maximum height for shadings 12" to 17 1/2" wide is 106" or the max height specified in the Max Height chart if shorter than 106", max would be whichever is shorter.

Cordless Lift - 84" maximum height applies to shadings over 24" wide. Maximum height for shadings 18" to 22" wide is 60". Maximum height for shadings 22 1/8" to 24" wide is 72".

Two-On-One Headrail - Maximum single panel width is 108". With unequal panels, the smaller panel must be at least one-third the width of the larger. Maximum height limitations apply to each individual panel. Two-On-One Headrail option not available for end mount applications.

Automation charts on page 8

BLISS Automation pricing. [Click here to view.](#)

Somfy Automation pricing. [Click here to view.](#)

PowerWand pricing. [Click here to view.](#)

**2" Light Dimming
Retreat (SR2)**

**2 1/2" Light Dimming
Villa (N6)**

**3" Light Dimming
Retreat (SR3)
Aspen LD (SL15A)
Oceanside LD (SL160)
Basketweave LD (SL17B)**

GROUP 3

WIDTH TO:	24"	30"	36"	42"	48"	54"	60"	66"	72"	76"	84"	90"	96"	102"	109"	120"
HEIGHT TO:																
36"	\$637	718	798	876	956	1040	1111	1194	1399	1487	1571	1654	1730	1835	2058	2247
42"	671	762	845	932	1022	1108	1194	1284	1499	1588	1676	1767	1853	1964	2193	2396
48"	707	802	899	984	1083	1181	1284	1376	1588	1684	1780	1879	1977	2093	2345	2561
54"	739	842	945	1048	1145	1252	1358	1469	1684	1791	1889	2002	2121	2243	2522	2754
60"	772	885	993	1100	1212	1332	1456	1571	1774	1889	2012	2131	2254	2403	2699	2949
66"	808	921	1048	1164	1284	1413	1542	1671	1873	2005	2135	2265	2396	2566	2893	3161
72"	845	971	1094	1216	1354	1499	1629	1767	1977	2121	2257	2396	2529	2714	3107	3390
78"	866	996	1138	1275	1413	1564	1705	1853	2069	2219	2370	2515	2658	2854	3332	3635
84"	902	1048	1181	1332	1490	1641	1800	1946	2178	2338	2493	2793	2919	3035	3574	3900
90"	942	1083	1231	1396	1564	1722	1886	2045	2277	2446	2745	2916	3042	3230	3747	4090
96"	1076	1231	1396	1568	1726	1879	2069	2254	2532	2693	2854	3013	3169	3390	3935	4294
102"	1231	1410	1588	1780	1936	2084	2341	2576	2778	2940	3103	3255	3418	3620	4174	4561

STANDARD FEATURES

- Light Block Strip on top of headrail for Inside Mounts(see page 13 for details)
- Color Coordinated Headrail
- Snap-in Bracket Style
- Cord Tilt & Lift
- Color-Coordinated Hardware

OPTIONS: EXTRA CHARGE

- Fabric Covered Headrail **add \$35 per shading**
- Hardware Color Substitution Surcharge **add \$30 per shading**
- Cordless Lift Surcharge **add \$90 per shading**
- Cordless Lift Two-on-One Headrail **add \$180 per shading**
- Retractable Wand **add \$90 per shading**
- Retractable Wand 2 On 1 Headrail **add \$180 per shading**

OPTIONS: NO CHARGE – SPECIFY ON ORDER

- Tilt Only Shadings 6" to 11-7/8" (Continuous Loop Control Only)
- Two-On-One Headrail – price as 2 separate shades
- Control Positions (R or L)
- Spacer Blocks
- Extension Brackets
- Hold-Down Brackets
- Back Cover for Inside or End Mounts
- Dust Cover for Outside Mounts

Notes:

- Hardware Color Substitution is only available when the Fabric-Covered Headrail option is not selected. Please review Collection Information pages for Coordinating Hardware Color
 - When Fabric-Covered Headrail is selected the underlying headrail color will always be white and the end caps will still be color coordinated.
 - Fabric-covered headrail is color-coordinated to fabric. If an override is chosen, please choose from a color in the Fabric- Covered Headrail color-coordination chart on page 4

SIZE STANDARDS-Single Panel	Continuous Loop Control	Retractable Wand
Minimum ordered width	12"	12"
Minimum ordered width – tilt only	6"	N/A
Maximum ordered width	120"	120"
Maximum ordered width end mount	48"	48"
Maximum ordered width – tilt only	11-7/8"	N/A
Minimum ordered height	16"	16"
Maximum ordered height-(see notes for limitations)	See Max Height Chart	See Max Height Chart

SIZE STANDARDS-Single Panel	Cordless Lift
Minimum ordered width	18"
Maximum ordered width	120"
Maximum ordered width end mount	48"
Minimum ordered height	12"
Maximum ordered height-All Fabrics (see notes for limitations)	84"

SIZE STANDARDS- TWO-ON-ONE HEADRAIL	Continuous Loop Control	Retractable Wand	Cordless Lift
Minimum ordered width	24"	24"	36"
Maximum ordered width (Overall)	144"	144"	144"
Maximum ordered width (Larger Panel)*	108"	108"	108"
Maximum height-(see notes for limitations)	See Max Height Chart	See Max Height Chart	84"
Center gap	3/8"	3/8"	3/8"

Max Height Chart for Continuous Loop Control and Retractable Wand.		
Maximum Height for Cordless is 84" on all fabrics.		
Fabric Code	Fabric Name	Max. Height
N6	Villa	102
N8	Classic	120
SA3	Coastal	90
SR2	Retreat	102
SR3	Retreat	102
SS2	Sophisticate	102
SS3	Sophisticate	120
SL12A	Aspen	120"
SL13O	Oceanside	120"
SL14B	Basketweave	120"
SL15A	Aspen Light Dimming	102"
SL16O	Oceanside Light Dimming	102"
SL17B	Basketweave Light Dimming	102"

For All Control Options - Maximum ordered width for end mount (EB) shadings is 48"
Retractable Wand - Maximum heights apply to shadings over 17 1/2" wide.
 Maximum height for shadings 12" to 17 1/2" wide is 106" or the max height specified in the Max Height chart if shorter than 106", max would be whichever is shorter.
Cordless Lift - 84" maximum height applies to shadings over 24" wide. Maximum height for shadings 18" to 22" wide is 60". Maximum height for shadings 22 1/8" to 24" wide is 72".
Two-On-One Headrail - Maximum single panel width is 108". With unequal panels, the smaller panel must be at least one-third the width of the larger. Maximum height limitations apply to each individual panel. Two-On-One Headrail option not available for end mount applications.

Automation charts on page 8

BLISS Automation pricing. [Click here to view.](#)

Somfy Automation pricing. [Click here to view.](#)

PowerWand pricing. [Click here to view.](#)

AUTOMATION SIZE STANDARDS FOR TRANSLUCENT AND LIGHT DIMMING

BLISS 1.1 LI-ION (INTERNAL BATTERY) SINGLE PANEL AUTOMATION	
Minimum Width	24"
Maximum Width	120"
Maximum Width - End Mount	48"
Minimum Height	12"
Maximum Height-Translucent	120"
Maximum Height-Light Dimming	102"
Maximum Square Feet - Translucent	60
Maximum Square Feet - Light Dimming	50

BLISS 1.1 LI-ION (INTERNAL BATTERY) 2 ON 1 HEADRAIL	
Minimum Width (overall)	48"
Minimum Width (per panel)	24"
Maximum Width (overall)	144"
Maximum Width (per panel)	120"
Maximum Width End Mount	N/A
Minimum Height	12"
Maximum Height - Translucent	120"
Maximum Height-Light Dimming	102"
Maximum Square Feet - Translucent	60
Maximum Square Feet - Light Dimming	50

BLISS 1.1 DC SINGLE PANEL AUTOMATION	
Minimum Width	19"
Maximum Width	120"
Maximum Width - End Mount	48"
Minimum Height	12"
Maximum Height - Translucent	120"
Maximum Height - Light Dimming	102"
Maximum Square Feet - Translucent	60
Maximum Square Feet - Light Dimming	50

BLISS 1.1 DC 2 ON 1 HEADRAIL	
Minimum Width (overall)	38"
Minimum Width (per panel)	19"
Maximum Width (overall)	144"
Maximum Width (per panel)	120"
Maximum Width - End Mount	N/A
Minimum Height	12"
Maximum Height - Translucent	120"
Maximum Height - Light Dimming	102"
Maximum Square Feet - Translucent	60
Maximum Square Feet - Light Dimming	50

SOMFY SONESSE 28 WIRE FREE RTS / ZIGBEE LI-ION (1.1 Nm) (INTERNAL BATTERY) SINGLE PANEL AUTOMATION	
Minimum Width	26"
Maximum Width	120"
Maximum Width - End Mount	48"
Minimum Height	12"
Maximum Height - Translucent	120"
Maximum Height - Light Dimming	102"
Maximum Square Feet - Translucent	60
Maximum Square Feet - Light Dimming	50

SOMFY SONESSE 28 WIRE FREE RTS / ZIGBEE LI-ION (1.1 Nm) (INTERNAL BATTERY) 2 ON 1 HEADRAIL	
Minimum Width (overall)	52"
Minimum Width (per panel)	26"
Maximum Width (overall)	144"
Maximum Width (per panel)	118"
Maximum Width - End Mount	N/A
Minimum Height	12"
Maximum Height - Translucent	120"
Maximum Height - Light Dimming	102"
Maximum Square Feet - Translucent	60
Maximum Square Feet - Light Dimming	50

SOMFY SONESSE 28 WIRE FREE RTS / ZIGBEE (1.1 Nm) DC SINGLE PANEL AUTOMATION	
Minimum Width	19"
Maximum Width	120"
Maximum Width - End Mount	48"
Minimum Height	12"
Maximum Height - Translucent	120"
Maximum Height - Light Dimming	102"
Maximum Square Feet - Translucent	60
Maximum Square Feet - Light Dimming	50

SOMFY SONESSE 28 WIRE FREE RTS / ZIGBEE (1.1 Nm) DC 2 ON 1 HEADRAIL	
Minimum Width (overall)	38"
Minimum Width (per panel)	19"
Maximum Width (overall)	144"
Maximum Width (per panel)	120"
Maximum Width - End Mount	N/A
Minimum Height	12"
Maximum Height - Translucent	120"
Maximum Height - Light Dimming	102"
Maximum Square Feet - Translucent	60
Maximum Square Feet - Light Dimming	50

POWERWAND™	
Minimum Width	22"
Maximum Width	120"
Maximum Width End Mount	48"
Minimum Height	12"
Maximum Height - Translucent	120"
Maximum Height - Light Dimming	102"
Maximum Square Feet - Translucent	60
Maximum Square Feet - Light Dimming	50

POWERWAND™ 2 on 1 HEADRAIL	
Minimum Width	44"
Minimum Width (per panel)	22"
Maximum Width (overall)	144"
Maximum Width (per panel)	120"
Maximum Width End Mount	48"
Minimum Height	12"
Maximum Height - Translucent	120"
Maximum Height - Light Dimming	102"
Maximum Square Feet - Translucent	60
Maximum Square Feet - Light Dimming	50

FEATURES & OPTIONS

FEATURES	
# of fabric styles	13
# of Colors	97
Headrail size	3-1/4" X 3-1/16"
Bracket style	Snap-in
Continuous Loop Control tilt and lift	Yes, Standard
Raise, lower and tilt with one cord	Yes
Universal Cord Tensioner	Color Coordinated
Warranty	Lifetime Limited

OPTIONS - EXTRA CHARGE	
Hardware Color Substitution	Yes
Cordless Lift	Yes
Fabric Covered Headrail	Yes
PowerWand	Yes
Bliss Automation	Yes
Somfy Automation	Yes
OPTIONS - NO CHARGE	
Tilt Only (available on continuous loop control only)	Yes
Two-On-One Headrail Option	Yes
Control positions	Right or Left
Motor Positions- Bliss, Somfy	Right or Left * (see note below)
Control Positions PowerWand	Right or Left * (see note below)
Wand Color - PowerWand	White, Black, Brown, Vanilla, Gray (see inset below)
Wand Length - PowerWand	1 ft, 2 ft, 3ft, 4 ft, 5 ft, 6ft
Spacer blocks	Yes
Extension brackets	Yes
Hold-down brackets	Yes
Back cover (Inside or End Mounts)	Yes
Dust cover (Outside Mounts)	Yes
Cord length (See Continuous Loop Control Drop Chart)	Yes
Specialty shapes	No
Tile cut-out	No

Note: For 2 on 1 shades, motors must be placed at the edges(far-left and far-right) of the shades.

Powerwand Colors



CONTINUOUS LOOP CONTROL CHART

SHADING HEIGHT	CORD LOOP DROP
16" to 26-7/8"	1 ft. (white-only)
27" to 39-7/8"	2 ft.
40" to 59-7/8"	3 ft.
60" to 83-7/8"	4 ft.
84" to 107-7/8"	5 ft.
108" to 120"	6 ft. (white-only)

OPTIONAL CORD DROPS (White Cord Only)	
CORD DROP	INCREMENTS
6' - 12'	6" increments
12' - 16'	12" increments

NOTE: 18" white only cords available upon request

MOUNTING REQUIREMENTS

INSIDE MOUNT (IB)	
Continuous Loop Control, Retractable Wand, Cordless Lift, Bliss Automation, Somfy Automation & PowerWand	
Minimum casement depth*	1"
Minimum casement depth*, fully recessed	3-5/16"
Minimum rear fabric clearance	1/8"

OUTSIDE MOUNT (OB)	
Continuous Loop Control, Retractable Wand, Cordless Lift, Bliss Automation, Somfy Automation & PowerWand	
Minimum mounting surface height	1"
Recommended width overlap per side	3"
Minimum rear fabric clearance	1/8"

END MOUNT (EB)	
Continuous Loop Control, Retractable Wand, Cordless Lift, Bliss Automation, Somfy Automation & PowerWand	
Minimum mounting surface depth*	1-1/4"

* Add 1/4" to minimum depth dimensions if optional back cover is used for inside or end mounts.

* End Mount not available on 2 on 1 applications.

The external battery pack available for Bliss 1.1 DC or for Sonesse 28 WireFree RTS / ZIGBEE DC are approximately 10" in length and 1" x 1". Consider ordering one of the Battery Pack Extensions below for mounting flexibility.

BLISS

48" Battery Pack Extension (Motor to Battery) Part #62207000

SOMFY

10" Battery Pack Extension (Motor to Battery) Part #9018623

48" Battery Pack Extension (Motor to Battery) Part #9016736

96" Battery Pack Extension (Motor to Battery) Part #9018624

HEADRAIL DIMENSIONS

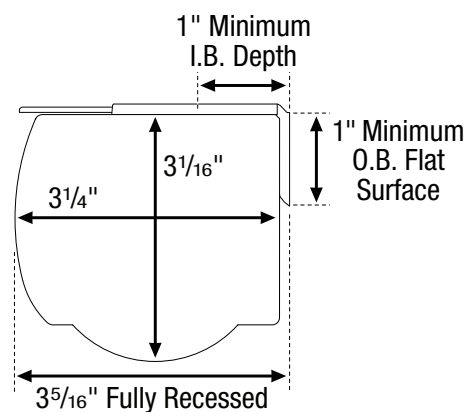

FINISHED DIMENSIONS

Dimensions apply to single panel Continuous Loop Control (CLC), Retractable Wand, Cordless Lift and PowerWand (PW single panel and PW 2 on 1)	
INSIDE MOUNT (IB)-Standard Deductions	
Headrail unit width	1/4" less than ordered width
Fabric width- (CLC,Retractable Wand,PowerWand)	1-1/8" less than ordered width
Fabric width - (Cordless Lift)	7/8" less than ordered width
Shading height-All	up to 1/4" less than ordered height
OUTSIDE MOUNT (OB)-Standard Deductions	
Headrail unit width	ordered width
Fabric width- (CLC,Retractable Wand,PowerWand)	7/8" less than ordered width
Fabric width - (Cordless Lift)	5/8" less than ordered width
Shading height-All	up to 1/4" less than ordered height
END MOUNT (EB)-Standard Deductions (not available with 2 on 1 applications)	
Headrail unit width	11/16" less than ordered width
Fabric width- (CLC,Retractable Wand,PowerWand)	1-9/16" less than ordered width
Fabric width - (Cordless Lift)	1-5/16" less than ordered width
Shading height-All	up to 1/4" less than ordered height

***Two-on-One Headrail not available with End Mount**

Bliss 1.1 Li-Ion and Bliss 1.1 DC (Single Panel and Two-on-One Headrail)	
INSIDE MOUNT (IB) - Standard Deductions	
Headrail unit width	1/4" less than ordered width
Fabric width-Single Panel	1-1/8" less than ordered width
Fabric width-Two-on-One	1-3/8" less than ordered width
Shading height	up to 1/4" less than ordered height
OUTSIDE MOUNT (OB) - Standard Deductions	
Headrail unit width	ordered width
Fabric width-Single Panel	7/8" less than ordered width
Fabric width-Two-on-One	1-1/8" less than ordered width
Shading height	up to 1/4" less than ordered height
END MOUNT (EB) - Standard Deductions	
Headrail unit width	11/16" less than ordered width
Fabric width	1-9/16" less than ordered width
Shading height	up to 1/4" less than ordered height

***Two-on-One Headrail not available with End Mount**

SOMFY Sonesse 28 Wire Free Li-Ion (Internal Battery) and Sonesse 28 Wire Free RTS / ZIGBEE DC (Single Panel and Two-on-One Headrail)	
INSIDE MOUNT (IB)- Standard Deductions	
Headrail unit width	1/4" less than ordered width
Fabric width-Single Panel	1-1/8" less than ordered width
Fabric width-Two-on-One	1-3/8" less than ordered width
Shading height	up to 1/4" less than ordered height
OUTSIDE MOUNT (OB) - Standard Deductions	
Headrail unit width	ordered width
Fabric width-Single Panel	7/8" less than ordered width
Fabric width-Two-on-One	1-1/8" less than ordered width
Shading height	up to 1/4" less than ordered height
END MOUNT (EB) - Standard Deductions	
Headrail unit width	11/16" less than ordered width
Fabric width	1-9/16" less than ordered width
Shading height	up to 1/4" less than ordered height

***Two-on-One Headrail not available with End Mount**

TWO-ON-ONE HEADRAIL	
Continuous Loop Control (CLC), Retractable Wand and Cordless Lift (Inside Mount-IB)	
Headrail unit width	1/4" less than ordered width
Fabric width- (CLC,Retractable Wand,PowerWand)	1-3/8" less than ordered width
Fabric width - (Cordless Lift)	1-1/8" less than ordered width
Gap between fabric panels	3/8"
Continuous Loop Control (CLC), Retractable Wand and Cordless Lift (Outside Mount-OB)	
Headrail unit width	ordered width
Fabric width- (CLC,Retractable Wand,PowerWand)	1-1/8" less than ordered width
Fabric width - (Cordless Lift)	7/8" less than ordered width

***Two-on-One Headrail not available with End Mount**

EDGE GAPS	
Continuous Loop Control & Retractable Wand	
Inside Mount(IB) – (from window opening edge to fabric)	
Control side	11/16"
Non-control side	7/16"
End Mount (EB)	
Control side	15/16"
Non-control side	11/16"
Cordless Lift	
Inside Mount(IB) – (from window opening edge to fabric)	
Both Sides	7/16"
End Mount (EB)	
Both Sides	11/16"
Automation	
Inside Mount(IB) – (from window opening edge to fabric)	
Control side	5/8"
Non-control side	3/8"
End Mount (EB)	
Control side	7/8"
Non-control side	5/8"

OPTIONS

TWO-ON-ONE HEADRAIL

Cover patio doors and other large expanses by placing two independently operated shades side-by-side on the same headrail. Note there will be a 3/8" light gap between the two shades, see minimum/maximum requirements under product specification section.

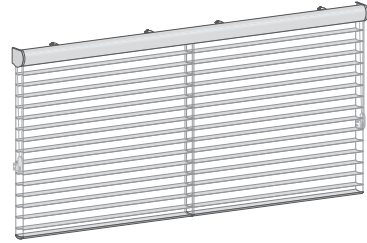

RETRACTABLE WAND

This system features a wand control for enhanced child safety. With one click, the fabric panel drops and the vanes open. Pull the wand straight down to close the vanes or raise the shading.

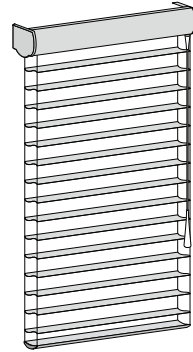

TILT ONLY SHADING

Ideal for sidelights or narrow windows.

- Shading cannot be raised, it can only be tilted open or closed.
- Hold down brackets are used to secure the bottomrail.

CORDLESS LIFT

Raise, lower, and tilt shadings with cordless lift. A great choice for homes with children and pets, the lift, lower, and tilt mechanism are all controlled by the clear plastic handle attached to the bottomrail.

This cordless system works by simply pushing up with your hand to raise the shading and pulling down to lower it. The shadings stay right where you put them.

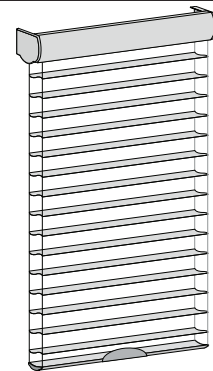

FABRIC-COVERED HEADRAIL

Features a coordinating fabric wrapped onto the headrail to provide a soft fabric look from top to bottom. (See surcharge on pricing pages)

Notes:

- Hardware Color Substitution is only available when the Fabric-Covered Headrail option is not selected
- When Fabric-Covered Headrail is selected the underlying headrail color will always be white and the end caps will still be color coordinated.
- Fabric-covered headrail is color-coordinated to fabric. If an override is chosen, please choose from a color in the Fabric-Covered Headrail color-coordination chart on page 4.

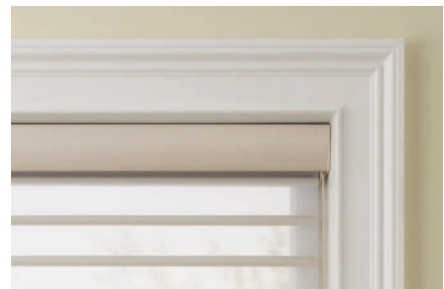

OPTIONS

OPTIONAL BACK COVER (INSIDE MOUNT)

Used with inside mounts to conceal the open rear side of the headrail for a more pleasing exterior look. Use of the back cover adds 1/4" to minimum inside mounting depths.

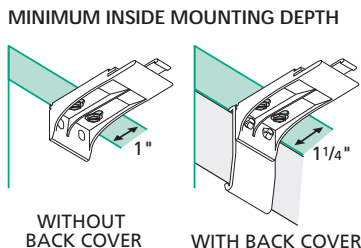

The back cover is secured in place by a back cover bracket attached to the installation bracket.

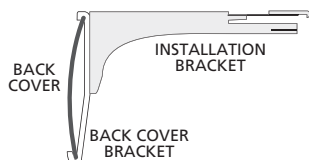

OPTIONAL DUST COVER (OUTSIDE MOUNT)

Shields the fabric and internal headrail components from dirt, dust, and other contaminants.

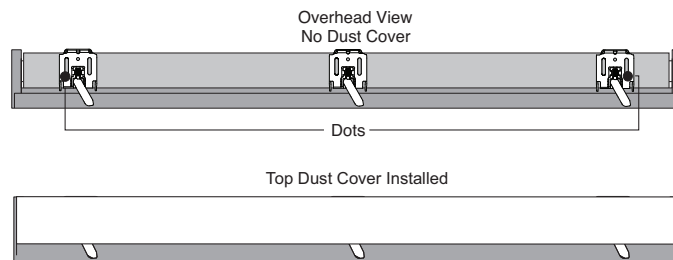

BACK COVER BRACKET

When a back cover is used, attach back cover brackets to the installation brackets before mounting them. Remove the tab from the top of the back cover brackets and both tabs at the rear of the installation brackets.

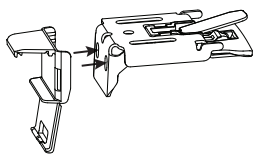

After mounting the installation brackets, install the back cover.

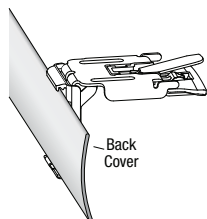

SIDE-BY-SIDE VANE ALIGNMENT

When sheer shadings are installed side by side, vane alignment can be guaranteed within 1/4" only if:

- Shadings are ordered at the same time and in the identical style, color and height.
- Shadings that need to be aligned are specified on the order form (a note must be included in Special Instructions).
- Shadings exceeding combined width of 120" cannot be guaranteed

Note: Vane alignment cannot be guaranteed for Two-On-One Headrail and motorized shadings combined on the same order.

ADJACENT SHADINGS

To span wide window openings, sheer shadings may be installed adjacently, so their headrails abut. The gap between the fabric panels of the adjacent shadings varies according to the control placement, as shown in the table below.

ABUTTED SHADINGS FABRIC GAP	
Cordless Lift	All abutting configurations 7/8"
Retractable Wand	Non-control sides abut 7/8"
Retractable Wand	Non-control sides abut control side 1-1/8"
Retractable Wand	Control sides abut 1-3/8"
Continuous Loop Control	Non-control sides abut 7/8"
Continuous Loop Control	Non-control sides abut control side 1-1/8"
Continuous Loop Control	Control sides abut 1-3/8"
Automation	All abutting configurations 1"

Note: Outside mount (OB) shadings are not recommended for bay windows or abut-and-pass applications.

ADDITIONAL NOTES

SHADING ADJUSTMENT

Shadings should wind evenly and not skew to one side.

A balance weight on the bottomrail can easily be adjusted if the fabric winds unevenly on the roll when the sheer shading is raised. Uneven winding can cause damage to the edge of the fabric.

- If skewing does occur:
 - Ensure headrail was installed level; shim if necessary.
 - To release, insert a flat blade screwdriver into the weight lock and turn clockwise.
 - Adjust placement of weight in bottomrail, 1" at a time, toward side where fabric is gathering.
 - Secure the weight locks in position by turning them counter clockwise, after making the adjustment.
 - Raise shade, then lower, if necessary, adjust again.

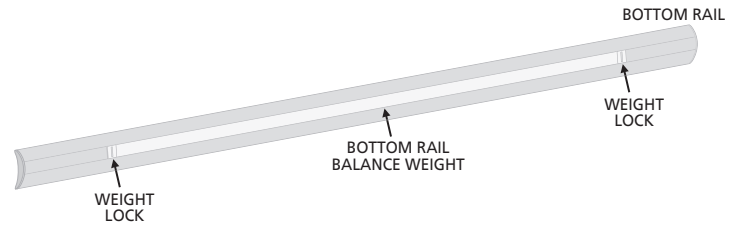

SHADING INSTALLATION

To mount the shading, insert the top of the headrail into the brackets between the locking tab and the bracket flange. Push the headrail into the brackets until the locking tab clicks in place.

To remove the shading, lift the locking tab to release the headrail, rotate the headrail forward, and pull it straight out.

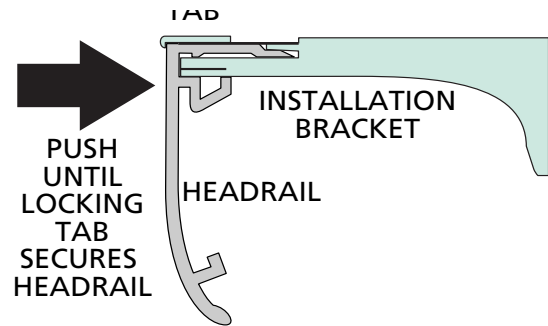

MAGNETIC HOLD-DOWN BRACKETS

Magnetic hold-down brackets secure the bottom of the shading to prevent swaying. Available upon request. Standard on tilt-only shadings.

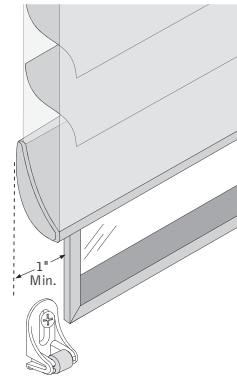

LIGHT BLOCK STRIP

An integrated light block strip comes standard on all inside mount headrails. The light block strip can be removed by removing the headrail decorative end cap. Using a square drive screwdriver, back the screw out of the endplate 1/8", keeping the screw attached. Gently pull the endplate to separate from the headrail. Using a pair of needle-nose pliers, grab the light-blocking strip and pull it out of the headrail channel (see photos to the right). Push the endplate to seat back into the headrail. Tighten the endplate screw and replace the end cap cover.

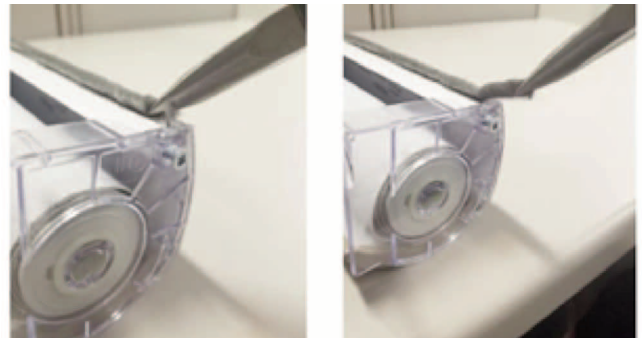

CONTINUOUS LOOP CONTROL OPERATION AND NOTES ON VANE OPENING, VANE CLOSURE AND LIGHT CONTROL

STANDARD SHADING OPERATION

Shadings are operated using a Continuous Loop Control. As shown in the illustration below, from the fully raised position [1] pulling down on the rear half of the cord loop lowers the shading [2, 3]. After it is fully lowered, continuing to pull down on the cord pivots the bottomrail and opens the fabric vanes [4]. When the vanes are fully open [5], limit stops in the headrail prevent further movement in that direction.

With the fabric vanes fully open, pulling down on the front half of the cord loop first closes the vanes [6, 7] and then raises the sheer shading [8]. When the shade is fully raised [1], limit stops again halt shading movement, preventing the bottomrail from being retracted too far into the headrail.

Light Control

With the shading in the fully lowered position, the selected control system is used to adjust the fabric vanes from open to closed, and anywhere in between. Light control is at your customer's fingertips. (Note: The degree of maximum vane closure varies slightly from the top to the bottom of the shading.)

Vane Opening

Vane opening is the amount of unobstructed visibility between fully open vanes when looking through the shading at eye level. Vane opening for shadings is 1" to 1-1/2" depending on vane size and opacity.

- 2" Light Dimming = 1"
- 2" and 2-1/2" Translucent, 2-1/2" Light Dimming = 1-1/4"
- 3" Translucent and Light Dimming = 1-1/2"

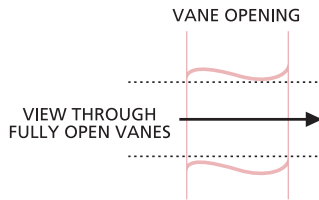

Vane Closure

When the vanes of a sheer shading are closed, they overlap each other, blocking the view. However, the vanes do not contact each other along the full length of the shading – they do not form a perfect seal against light leakage. This is most visible toward the bottom of the shading. Vane closure is measured

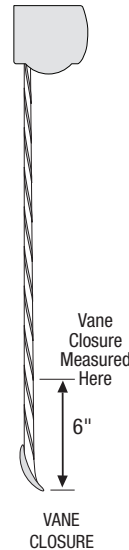

as the distance between the front and rear fabric facings 6" up from the lowest point of the bottomrail, with the shading fully lowered and the vanes closed, as illustrated here. Vane closure for all fabrics is 1".

Note: The degree of maximum vane closure varies slightly from top to bottom of the shading.

- Over-rotation can occur when the shading is completely lowered and vanes are opened. The bottom rail turns up to the inside of the opening when the vanes are in the horizontal position.

Note: Over-rotation is an inherent characteristic of Sheer Shadings. The amount of over-rotation may vary from shade to shade.

PLEASE NOTE:

- Cord tensioner **MUST** be mounted to window casement or wall in order for the shade to operate.
- As with all textiles, Sheer Shading fabrics are subject to some variations. Slight wrinkles, puckering or bowing is inherent to textile products and should be considered normal, acceptable quality.

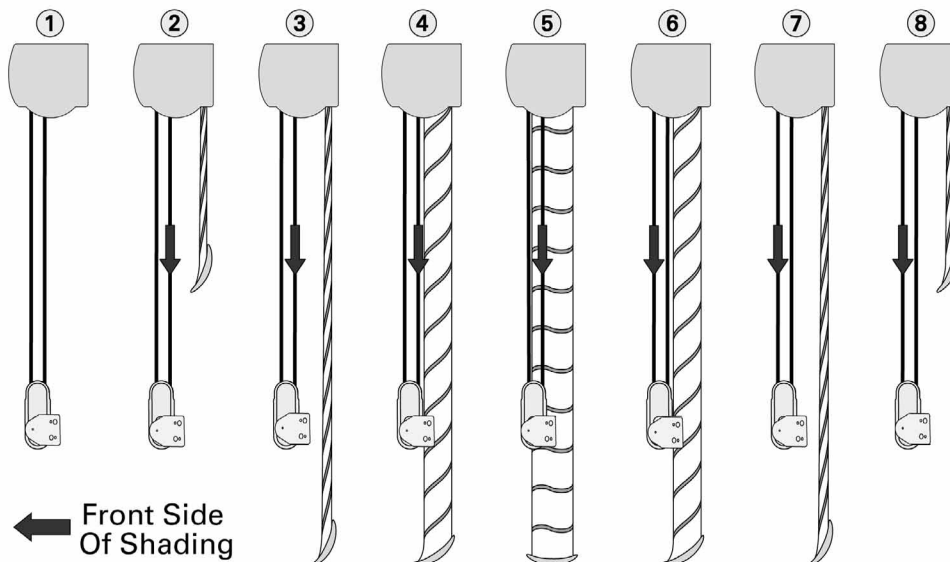

OPERATION

CORDLESS LIFT

Raise, lower and tilt shadings with cordless lift. A great choice for homes with children and pets, the lift, lower and tilt mechanism are all controlled by the clear handle attached to the bottom rail. This cordless system works by simply pushing up with your hand to raise the shading and pulling down to lower it. The shadings stay right where you put them.

- Slowly and steadily pull down on the bottom rail handle to lower the shading.
- With your thumb on the front of the handle and fingers on the back, gently pull the back of handle down and away from the shading to open the vanes.
- Use the handle to tilt the vanes to the desired open/closed position.
- Push down on the front of the handle to close the vanes.
- Slowly and steadily push up on the handle to raise the shading.

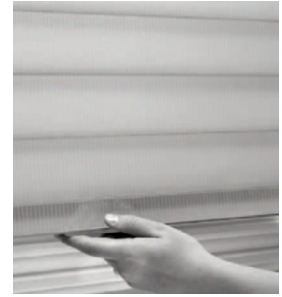
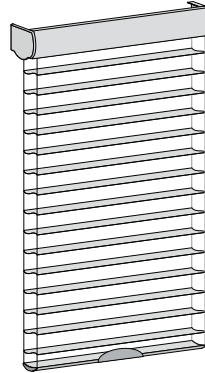

RETRACTABLE WAND

This system features a wand control for enhanced child safety. With one click, the fabric panel drops and the vanes open. Pull the wand straight down to close the vanes or raise the shading.

Operation:

To Lower the shading

- Pull the wand straight out from the fabric at an angle greater than 25 degrees. The clutch will click and the fabric will proceed with a controlled descent. The shading will lower and the vanes will open.
- To stop the shading in any position, simply pull the wand straight down.

IMPORTANT: Avoid pulling the wand in the non-operable zone. This is the area between the angle for lowering the shading and the straight down position for raising the shading. Refer to the illustration.

To Open the Vanes

- After lowering the shading completely, continue to pull on the wand at an angle greater than 25 degrees, until the vanes are fully open.

To Close the Vanes and Raise the Shading

- Hold the wand close to the fabric and pull straight down.
- Pump the wand down using short strokes to gradually raise the shading.

CAUTION: To avoid damage to the shading or personal injury, do not release the wand until it is fully retracted. To avoid breaking the wand, do not use long strokes (over 42") or apply excessive force on the wand while pulling it.

Wand Position

Select: Left or Right for Standard (Bottom-Up) shadings. With Two-On-One headrail, wand positions will be on the left side for the left shading and the right side for the right shading.

Wand Length

Specify wand length in 6" increments from 12" to 84".

- Recommended wand length for proper ergonomics is the wand handle at shoulder height of the user. For recommended measurements, see the Retractable Wand Measuring Guidelines section below.

Ordering Notes

Retractable Wand Measuring Guidelines

Control wands work best when ordered at a length approximately equal to the distance from the headrail to the shoulder of the user.

- Round the length to the nearest 6" increment when selecting the wand length. Wands are available from 12" to 84".
- Adjust the wand length as necessary for customer circumstances. The Retractable Wand should fall between the shoulder heights

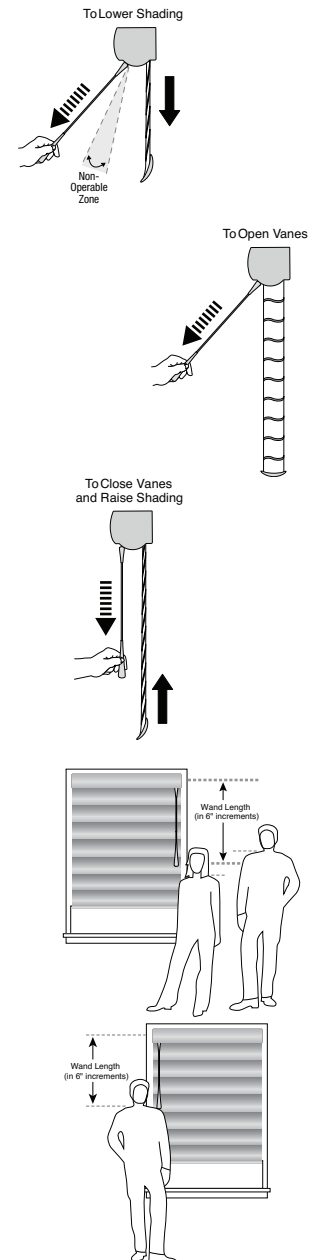



Midwest
Designer
Supply

1-888-523-2611

**Midwest Designer Supply, Inc.
N30W22377 Green Road Ste C
Waukesha, WI 53186
(262) 523-2600
Fax (262) 524-1007
www.midwestdesignersupply.com**

MDS - your one source for window fashions.